



# BIA-DPC1-22

Single-Phase, Dual Pump

Control and Protection Module PN 802691

Installation and Operation Manual Rev 6.0



# 1. Introduction

Thank you for choosing a Bianco iCon DPC (Dual Pump) Intelligent Pump Controller.

A DPC controller provides significant protection for single or dual, direct start (DOL), single phase pumps from 0.37kW – 2.2kW with PSC MOTORS (Permanent-Split Capacitor) with start and run windings.

The DPC Controller has a number of pre-programmed control and operation modes to suit a variety of applications.

The controller is easy to set up with a push button calibration.





The LCD screen displays the pump running state and provides the user a wealth of useful information.

A DPC controller is particularly useful where there is the need to control and protect dual pump installations managing the automatic operation by a variety of switching methods without the need to create a one-off control solution.







# 2. Contents

<b>1. Introduction .....</b>	<b>2</b>
<b>2. Contents .....</b>	<b>2</b>
<b>3. ISO 7010 Symbols used in this manual.....</b>	<b>3</b>
<b>4. Warnings and Cautions .....</b>	<b>3</b>
<b>5. Quick guide to common button functions .....</b>	<b>5 – 6</b>
<b>6. Technical Specifications .....</b>	<b>6</b>
<b>7. Display .....</b>	<b>9 – 10</b>
<b>8. Electrical Connections.....</b>	<b>10</b>
<b>9. Parameter Calibration, erasing calibration and resetting.....</b>	<b>11</b>
<b>10. Communication link .....</b>	<b>12</b>
<b>11. Program Parameters .....</b>	<b>13</b>
<b>12. Quick guide: Drainage Pumps, floats connected to panel .....</b>	<b>17</b>
<b>13. Quick guide: Drainage Pumps with floats connected. ....</b>	<b>18</b>
<b>14. Quick guide: Pressure boosting .....</b>	<b>19</b>
<b>15. Quick guide: Transfer; source and destination control.....</b>	<b>20</b>
<b>16. Quick guide: Transfer mode - thermostatic control.....</b>	<b>21</b>
<b>17. Fault messages – possible causes and solutions.....</b>	<b>22</b>
<b>18. Warranties – Terms and Conditions .....</b>	<b>23</b>

### 3. ISO 7010 Symbols used in this manual

	Warning - Electrical safety
	Warning – Potential consequences of use outside of intended application(s). Includes environmental condition warnings.
	Mandatory warning
	Warning to disconnect power
	Read carefully

### 4. Warnings and Cautions

	Read the manual carefully before starting and retain for future reference.
	Prior to starting installation or maintenance the controller must be disconnected from the power supply. Allow the internal electronics to discharge before opening the cover
	Any changes or modification to the wiring must be carried out by competent, skilled and suitably qualified personnel only.
	A qualified electrician should correctly size and install circuit breakers to protect the power supply. The fitment of additional surge protection is recommended.
	Never open the cover while controller is connected to electrical supply. Disconnect and allow the internal electronics to discharge before opening the cover
	This appliance is not intended for use by persons (including children) with reduced physical, sensory or mental capabilities, or lack of experience and knowledge, unless they have been given supervision or instruction concerning use of the appliance by a person responsible for their safety. Children should be supervised to ensure that they do not play with the appliance.
	Ensure the controller is a suitable size for the pump motor (see Section 6. Technical Data). Size according to P1 power.

## 5. Quick guide to common button functions

### Switching to Manual mode (controller locked)



Hold   for 10 seconds to move from Auto to Manual mode.

The display will indicate  MODE. Any operational pumps will stop.



Individual pumps can now be operated manually by pressing A Pump or B Pump Start / Stop as required.



The display will indicate:

- the voltage available and
- the current (amperage) the pump is drawing.

**If the amperage is outside of the programmed range the controller will stop the pump and display the relevant error code.**



### Last 5 error messages

A Pump: Hold down  then press 

B Pump: Hold down  then press 

*Repeated presses of*  
  
*will cycle through the last 5 errors*

### Alarm Test

In  mode and pump(s) not operating press  for 3 sec to test the alarm.

### Alarm Mute

AT ANY TIME press  to mute the alarm.

### Returning to Automatic mode.

Short press  The display will indicate that the unit is in  mode.

### Pump Protections

The control unit monitors voltage and current continuously. With the pump(s) running, if a situation arises where the pump is operating outside of its programmed parameters i.e., dry run, overload, over voltage, etc, the control panel will shut down the affected pump and switch to the second.

The non-critical parameters will automatically re-set after the programmed period.

## 5. Quick guide to common button functions cont.

### Pump Stalled

Pump stall alarms are considered a CRITICAL CONDITION. Generally it indicates something jamming the impeller or in the case of macerating pumps, the cutting mechanism.

In the event of pump stall, open phase or other serious failure the controller requires manual resetting (power cycling) following pump inspection.

### Pump accumulative running time

The DPC controller tracks how many hours each pump runs which enables the pump user to analyse the pump running conditions and schedule maintenance.

Hold **MODE** **STORE** for 10 seconds to move from Auto to Manual mode.  
The display will indicate **MANUAL** MODE. Any operational pumps will stop.

PRESS and HOLD the **STORE** key. Press **A STOP** or **B STOP**

The control panel will beep and display the accumulative pump run time.

Press **A STOP** or **B STOP** to exit.

### Pump Disable/Enable

The controller must be in **AUTO** mode

Press **A STOP** OR **B STOP** AND **MODE** TOGETHER to disable a pump.

Press **A START** OR **B START** AND **MODE** TOGETHER to enable a pump.

### Pump Calibration

Hold for **MODE** **STORE** 10 seconds to move from Auto to Manual mode.

The display will indicate **MANUAL** MODE.

Press **A START** or **B START** and allow the pump to run until it is running at its duty point and the amps stabilize.

Press **STORE** The control panel will beep. Press **MODE** to return to **AUTO**

## 6. Technical Specifications

Controller Modes	Automatic or Manual pump operation for dual pumps. Liquid level control via float switch, level transducer or pulse electrode probes. Pressure control via pressure switch or transducer
<b>Protection functions:</b>	Dry run (underload), Overload, Pump Stalled, Transient surge, Under voltage, Over voltage, Repeated start, Over temperature, Short circuit
Input Voltage	<b>230V +5% -10%</b>
Rated output power	2 x 0.37 – 2.2kW P2 power (rated up to 25A input)
Working temp	-25 to +55 deg C 20% to 90% relative humidity, non-condensing
Controller size	302mm wide, 240mm tall, 120 deep. IP54
Trip response times (set)	Open phase – Less than 2 sec Short circuit – less than 0.1 sec
Trip Voltage (User adjustable)	Over voltage – 115% of rated input voltage default Under voltage – 70% of rated input voltage default
Trip response times (User adjustable)	Dry run (Under-load) 6 sec Overload Default 5 min Under Voltage Less than 5 sec Over voltage Less than 5 sec
Recovery times	Dry run (Under-load) 30 min default Overload 30 min default Under Voltage 2 min default Over voltage 2 min default
RS485 Technical interface	RS485 Bus Interface: asynchronous semi duplex 1200,2400,4800,9600 bps (default 9600bps) MODBUS protocol (RTU)
Alarms	Visual and audible alarm. Supports external alarm connection <i>12V 3W DC</i>



Avoid installing the DPC where it could experience the following conditions:

- i. Where there is significant vibration and/or mechanical shock.
- ii. Where it could be exposed to corrosive liquids or gasses, or to flammable materials, solvents etc.
- iii. Extreme heat and cold. Operating range -25°C - 55°C.
- iv. Protect the controller from rain, moisture, humidity or dust



### Remote Alarm

1. Position alarm on top of the enclosure and feed cable through hole with grommet
2. Fix alarm in place with hardware supplied
3. Mount controller inside enclosure using hardware supplied
4. Feed alarm cable through one of the cable glands and connect to terminal strip J22
5. Set dip switch beside J22 in the down position (In-built alarm OFF)
6. J22 terminals rated 12VDC 125mA, 1.5W



Terminal strip J22 Toggle switches

### Cover

Part Number	Item Code	Description
<b>BIA-iCOVER</b>	<b>802700</b>	Metal enclosure for control panel with lockable door. Includes 803417 audio and visual alarm. 500W x 400H x 200D

## 7. Display

The DPC display provides a real time indication of the operational mode and the current state of the controller, including real-time voltage/current and any error messages.

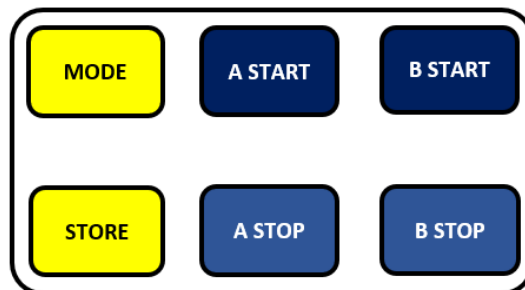
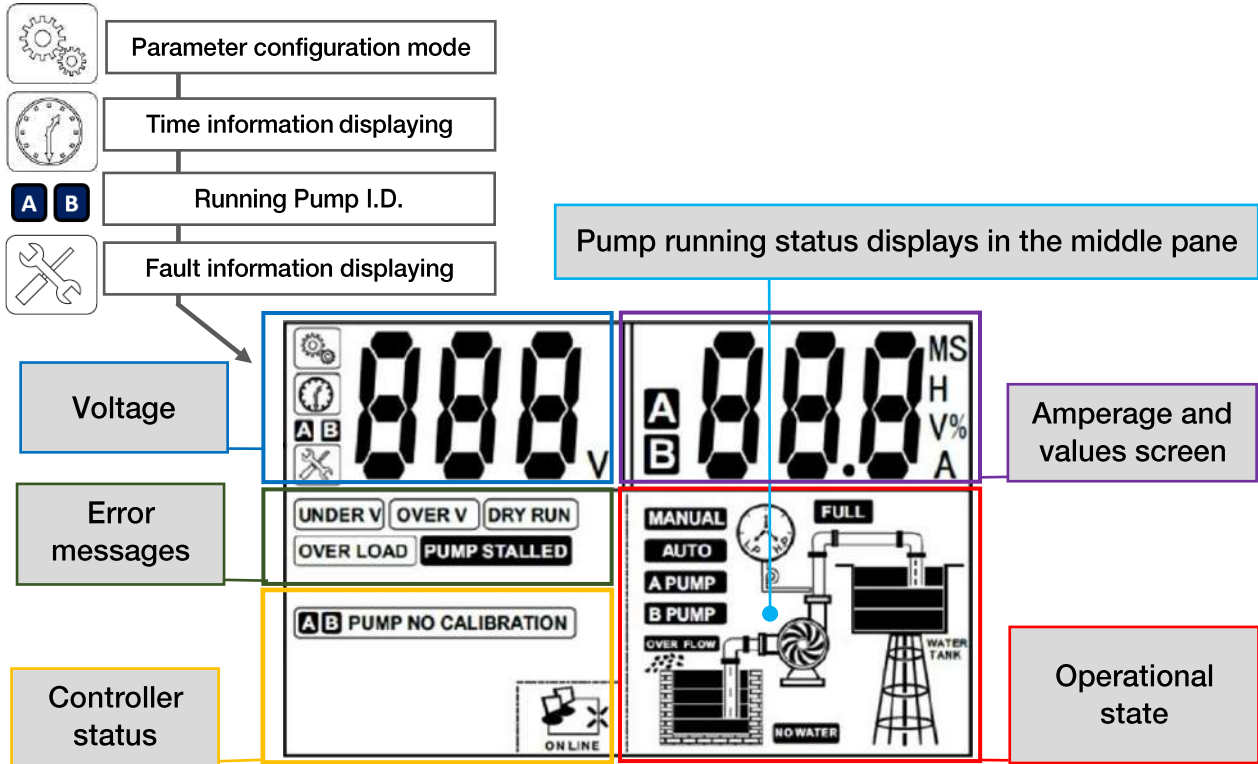

The controller is managed using the buttons on the front cover and a sequence of short, long and combination button presses as detailed in this manual



Remote monitoring and (limited) control can be achieved using the SC2 remote monitor



## 7. Display con't

The DPC controller operates according to pre-programmed logic applied to each 'mode'. Changing the Dip Switches inside the controller then **cycling the power** will activate the selected logic mode.

Examples of common applications are detailed at the rear of this manual but with an understanding of how the controller responds to various inputs in each of the modes the controller can be used for application other than what is suggested.

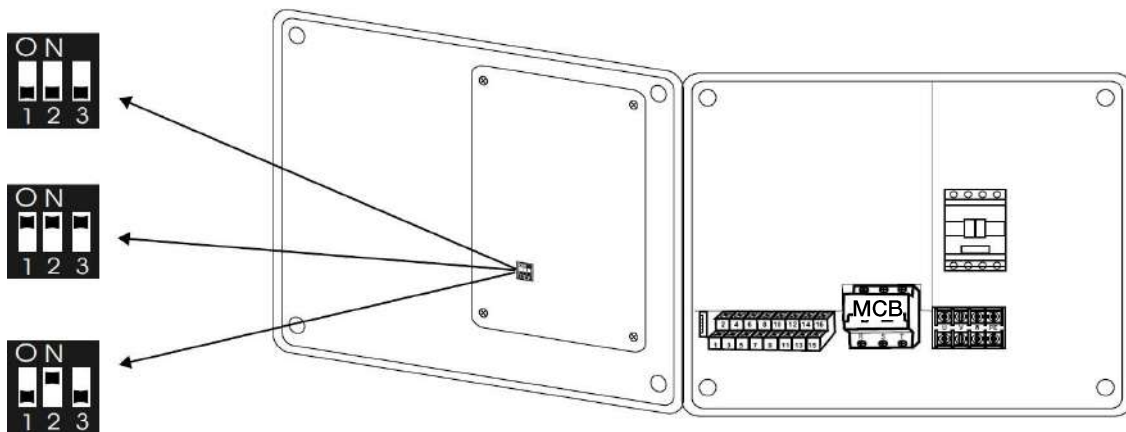

The appearance of the front display changes according to each mode and provides a visual indication to the state of the input signals.

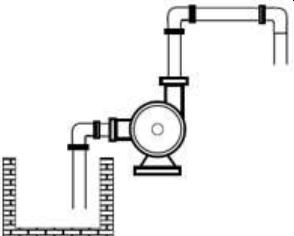
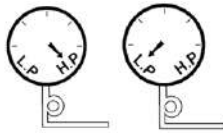
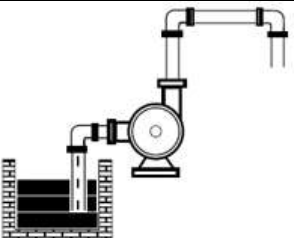
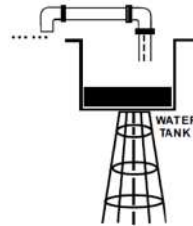
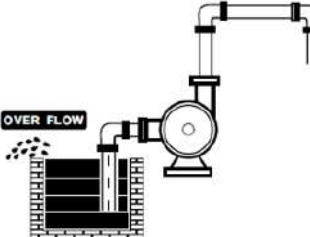
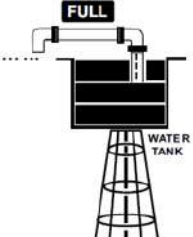
	Lack of source water		High pressure Low pressure
	Source water full		Destination low
	Overflow		Destination full

## 8. Electrical Connections

Always use an electrical outlet that is protected by Residual Current Device (RCD) Safety Switch with a trip current of 30mA or less. A Safety switch is required by Australian/New Zealand Standard AU/NZS 60335.1-2011.



This must be connected by a suitably qualified technician.

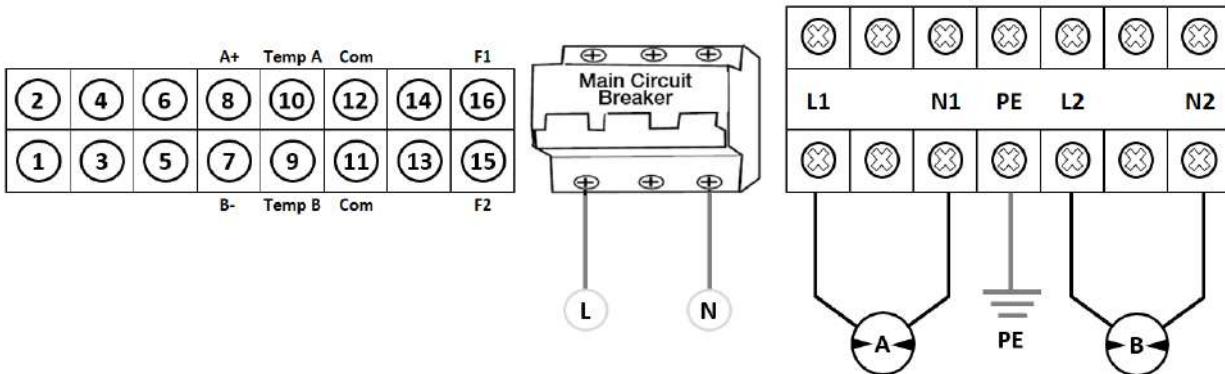

### Other terminals.

Terminals 7 & 8      MODBUS communication to Slave Controller or BMS

Terminals 15 & 16      N.O. Close on fault

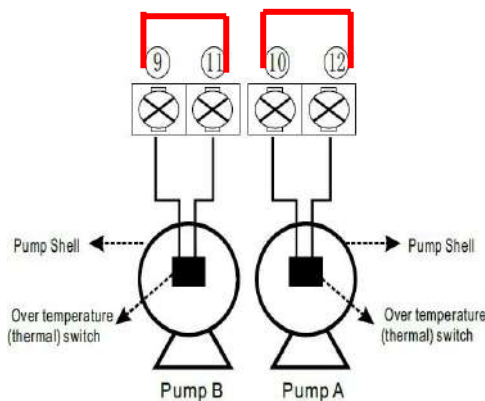

Terminals 9 & 11 and 10 & 12 for connection to motor thermal protection (microtherms) where available.

If the pump isn't fitted with microtherms, leave jumper wires in.

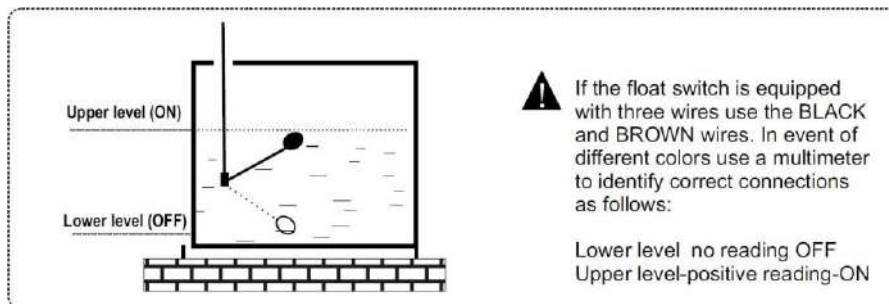

*Float Down NC, Float Up NO*

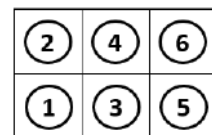

Terminals 1 – 6 are used to connect the control inputs (floats, probes, switches) as detailed in the setup guides

## 9. Parameter Calibration, erasing calibration and resetting



Pump/s must be able to pump water to enable correct calibration. If pumps are calibrated without water, overload and pump stalled errors may occur later.

Calibration can be performed automatically as detailed in the installation guides or by accessing the parameter menu and manually inputting the desired value

When a new pump is installed, or an existing pump reinstalled after maintenance, erase the former calibration and a perform a fresh calibration.

### Erasing the parameter calibration

Press and Hold **MODE** **STORE** for 10 seconds to move from Auto to Manual mode.  
The display will indicate **MANUAL** mode.

Press the **A STOP** and/or **B STOP** key for 30 seconds; the control panel makes a “beep” sound, and the control panel recovers the default factory setting and the LCD displays: No Calibration flashing.

Press **MODE** to return to **AUTO** mode.

Under auto state the control panel will run or stop the pump according to the signals from the liquid level probes, float switch, pressure switches or other connected inputs.

- **Note:** When a pump is running in **AUTO** mode and user wants to stop the pump, switch to **MANUAL** mode and the pump stops.
- Under **AUTO** mode, if the input power is cut off and the recovers, the control panel will enter an operational state after 10 seconds countdown.
- Whether in **AUTO** or **MANUAL** state, if the input power is cut off and recovers again, the control panel will resume its operation in the same state as before the power supply was interrupted.

### Pump re-calibration

Press and Hold **MODE** **STORE** for 10 seconds if the unit is in Auto mode.  
The display will indicate **MANUAL** mode

Press **A START** or **B START** and allow the pump to run until the pump is running at its duty point and the amps stabilize.

Press **STORE** The control panel will beep. Press **MODE** to return to **AUTO**

## 10. Communication link

The control panel has communication interface, that along with the optional remote monitor user interface, it is possible to monitor and control the controller remotely.

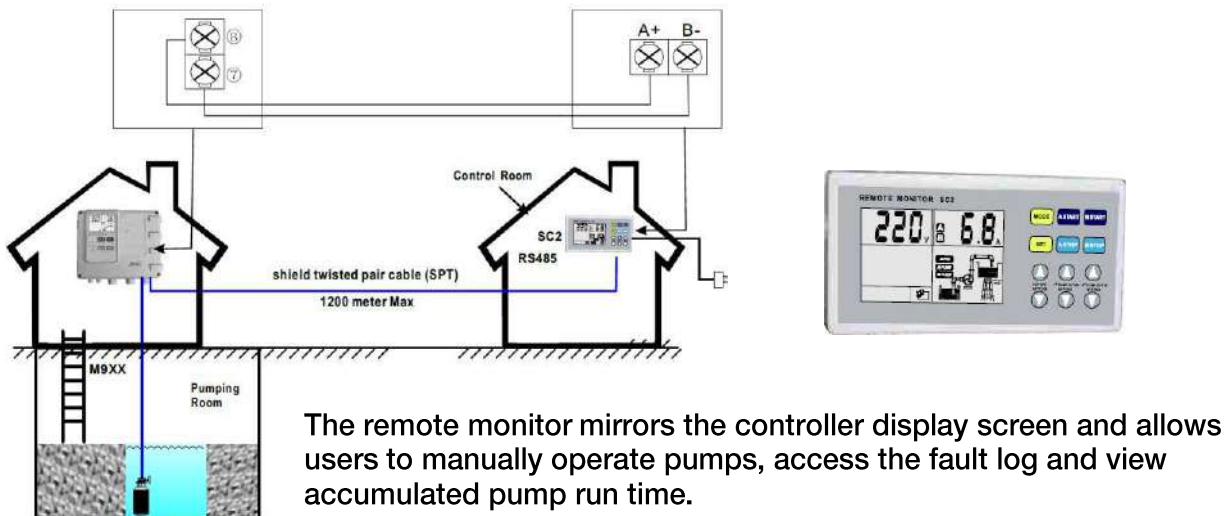

A USB-A to USB Mini-A can be used to connect and power the slave controller however there are limitations to the cable length that will work reliably.

The communication interface, wire communication distance is less than 1200 metres. For those installation environments which require a longer distance communication, users can adopt RS485 extender, wireless communication or GSM.

Please contact White International for more information.

Main technical data	
Physical interface	RS485 Bus Interface: asynchronous semi duplex
Data format	1 start bit, 8 data bit, 1 stop bit, no verify 1 start bit, 8 data bit, 2 stop bit, no verify Default: 1 start bit, 8 data bit, 1 stop bit, no verify
Baud rate	1200,2400,4800,9600 bps (default 9600bps)
Communication address	Setting range of controller address: 1-126. 127: broadcast address, host computer broadcasting, slave machine response forbidden
Protocol type	MODBUS protocol (RTU)
Rated input voltage for SC	AC 240V/50Hz, single phase
Main installation data	
Wire communication distance	1200 m max by shield twisted pair cable (STP)for RS485 & CAN 5000 m max by STP and RS485 extender
STP	STP-120U one pair 20AWG for RS485 & CAN
RS485 extender	5000 m (9600bps)

# 11. Program Parameters

## Switch to Manual mode (controller locked)

Hold **MODE** **STORE** for 10 seconds.

The display will indicate **MANUAL** MODE. Any operational pumps will stop.













PRESS and HOLD **MODE** for 5 seconds to enter the parameter programming mode.

SHORT PRESS **MODE** to scroll through parameter menu.

SHORT PRESS **A START** to increase a value. SHORT PRESS **A STOP** to decrease a value.

PRESS to **STORE** exit.

This parameter list is current for Rev 6.0 firmware

<table border="1"> <tr> <td>001</td> <td>001</td> </tr> <tr> <td></td> <td></td> </tr> </table>	001	001			<p><b>The controller ID</b> Used to identify a unit in a Modbus system</p> <p>Range 0 - 254 Default = 1</p>
001	001				
					
<table border="1"> <tr> <td>002</td> <td>004</td> </tr> <tr> <td></td> <td></td> </tr> </table>	002	004			<p><b>RS 485 Speed</b></p> <p>01 = 1200 bps 02 = 2400 bps 03 = 4800 bps 04 = 9600 bps</p> <p>Range 0 - 4 Default 4 = 9600 bps</p>
002	004				
<table border="1"> <tr> <td>003</td> <td>006<sup>s</sup></td> </tr> <tr> <td></td> <td></td> </tr> </table>	003	006 <sup>s</sup>			<p><b>Dry run protection trip response time in seconds (S)</b></p> <p>Range 0 seconds – 60 seconds Default value 6 seconds</p>
003	006 <sup>s</sup>				
					
<table border="1"> <tr> <td>004</td> <td>030<sup>m</sup></td> </tr> <tr> <td></td> <td></td> </tr> </table>	004	030 <sup>m</sup>			<p><b>Recovery time for dry run protection in minutes (M)</b></p> <p>Range 0 - 254 minutes Default value is 30 minutes</p>
004	030 <sup>m</sup>				
					
<table border="1"> <tr> <td>005</td> <td>005<sup>m</sup></td> </tr> <tr> <td></td> <td></td> </tr> </table>	005	005 <sup>m</sup>			<p><b>Overload trip response time in seconds</b></p> <p>Range 0 - 60 seconds Default value is 5 seconds</p> <p>The reset time is a non-adjustable value of 5 min. E.g. if the current is above parameter 009 for 5 seconds, controller stops pump for 5 min.</p>
005	005 <sup>m</sup>				
					

## 11. Program Parameters con't

<p><b>006</b></p> <p>UNDER V OVER V</p>	<p><b>002<sup>m</sup></b></p>	<p><b>Under / Over voltage trip response time</b> in minutes (M)</p> <p>Range 0 – 60 minutes Default value is 2 minutes</p> <p><i>Under/Over voltage Parameters 012 and 013</i></p>
<p><b>A 007</b></p>	<p><b>28.0<sup>A</sup></b></p>	<p><b>Rated power output to Pump A</b></p> <p>Range 0 – 28 amps Default setting is 28 amps</p> <p>Button Press calibration saves the running value to this location</p>
<p><b>B 008</b></p>	<p><b>28.0<sup>A</sup></b></p>	<p><b>Rated power output to Pump B</b></p> <p>Range 0 – 28 amps Default setting is 28 amps</p> <p>Button Press calibration saves the running value to this location</p>
<p><b>009</b></p> <p>DRY RUN</p>	<p><b>70<sup>%</sup></b></p>	<p>The trip response ratio of the <b>dry-running (underload) protection</b> as a percentage of the rated current</p> <p>Range 0 – 95% Default setting is 70%</p>
<p><b>010</b></p> <p>OVER LOAD</p>	<p><b>115<sup>%</sup></b></p>	<p>The trip response ratio of the <b>Overload Protection</b> as a percentage of the rated current.</p> <p>Range 0 – 170% Default setting is 115%</p>
<p><b>011</b></p> <p>PUMP STALLED</p>	<p><b>170<sup>%</sup></b></p>	<p>The trip response ratio of the <b>Pump-Stalled Protection</b> as a percentage of the rated current.</p> <p>Range 0 – 240% Default setting is 170%</p> <p><i>A pump-stalled event is a 'critical error' and has no auto-restart time</i></p>
<p><b>012</b></p> <p>UNDER V</p>	<p><b>204<sup>v</sup></b></p>	<p>The trip voltage of the <b>Under Voltage Protection (V)</b></p> <p>Range 0 – 295V Default setting is 204V</p>
<p><b>013</b></p> <p>OVER V</p>	<p><b>276<sup>v</sup></b></p>	<p>The trip voltage of the <b>Over Voltage Protection (V)</b></p> <p>Range 0 – 295V Default setting is 276V</p>
<p><b>014</b></p>	<p><b>240<sup>H</sup></b></p>	<p><i>Note: Only Applicable to Drainage Mode</i></p> <p><b>Anti-seize parameter.</b></p> <p>In auto mode, if pump has not run for XX hours, controller will run the pump for 3 seconds.</p> <p>Range 0 – 254 hours                      Default setting is 240 hours.</p>

## 11. Program Parameters con't

<p><b>015</b></p>	<p><b>005<sup>m</sup></b></p>	<p><b>Auto Mute</b> function of Alarm When controller is in Critical Alarm state, after time interval of 014 has expired, the alarm changes from continuous sounding to chirp mode at one minute intervals until the alarm condition is reset.</p>
<p><b>016</b></p>	<p><b>010<sup>s</sup></b></p>	<p><b>Delay Start</b> of Pump in Auto Mode Once input sensors calls for pump to start, Timer 016 counts down and Pump Starts Function used to prevent multiple, rapid starts of pump.</p>
<p><b>017</b></p>	<p><b>012<sup>s</sup></b></p>	<p><b>Pump Stalled</b> Delay on start up When in Drainage mode, some pumps such as Grinders draw very high current on start up. To prevent controller interpreting as a Pump Stalled occurrence, the functionality of 010 can be delayed via setting 017</p>
<p><b>018</b></p>	<p><b>00</b></p>	<p><b>Phase Reversal Protection Function Selector</b> 00 – Phase Reversal function Active 01 – Phase Reversal function Active, but won't prevent pump start 02 – Phase Reversal function Inactive (Only applicable to DPC3, three phase controller)</p>
<p><b>019</b></p>	<p><b>015<sup>m</sup></b></p>	<p><b>High level Audible Alarm &amp; Lights</b> delay When in Drainage mode, this delays activation of audible alarm and warning light once high level float is activated for duration of time set at 019 Allows pump to lower level when rapid level change occurs without causing nascent alarming. Value must be greater than 000</p>
<p><b>020</b></p>	<p><b>15%</b></p>	<p><b>Phase Imbalance</b> – <b>Not applicable to the DPC1 controller</b> The control panel alarms, if any of the phases are out of balance by the set value; Default = 15% i.e. If a phase is lower by 15% the controller will alarm Setting the value to 0% disables this function</p>
<p><b>021</b></p>	<p><b>01</b></p>	<p><b>RST Open Phase.</b> <b>Not applicable to the DPC1 controller</b> The control panel alarms, when a phase is dropped; Default = 01 - Enabled Setting the value to 00 disables this function</p>

Previous firmware versions have fewer parameters, and the default values differ.

Please contact White International for advice when dealing with earlier generation controllers.

**If a replacement pump is installed, the previous calibration should be removed and a new calibration performed.**





iCon DPC controllers are a cost effective, reliable means to provide better control and protection without the need for costly bespoke switchboards

The following quick guides provide information regarding common applications.

The pumps illustrated in the following quick guides are all of a submersible type but the DPC controller is not limited to this type of pump.

With an understanding of how the controller responds to various inputs in each of the modes the controller can be used for applications beyond what is suggested.

For example, the controller can be connected in series with a VFD controlled pump to provide additional control inputs or to utilise the DPC controller delay times.

For even greatly flexibility in your installation the DPC controller can be used as a 'module' in a more complex control environment.





## 12. Quick guide: Drainage Pumps, floats connected to panel

**Set the dip switches on the inside of the door and cycle the MCB**



DRAINAGE SETTING SWITCHES DOWN

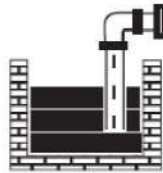

DRAINAGE SYMBOL

3 Floats connected

Bridge 3 - 5

- A** Lower level 1 - 5 **Single pump runs (On/Off)**  
If only one pump runs, the controller alternates which pump runs at each start
- B** Upper Level 2 - 4 **Second pump starts**  
Both pumps run until lowest float Float A (1 - 5) switches off
- C** High Level (Overflow) 2 - 6 **Buzzer sounds and alarm flashes**  
Both pumps run until lowest float Float A (1 - 5) switches off

4 Floats connected

Remove bridge 3 - 5

To provide greater differential at the lower level a 4th float can be added to 1 - 3

Terminals 9&11 and 10&12 are to connect microtherms  
Leave jumpers in place

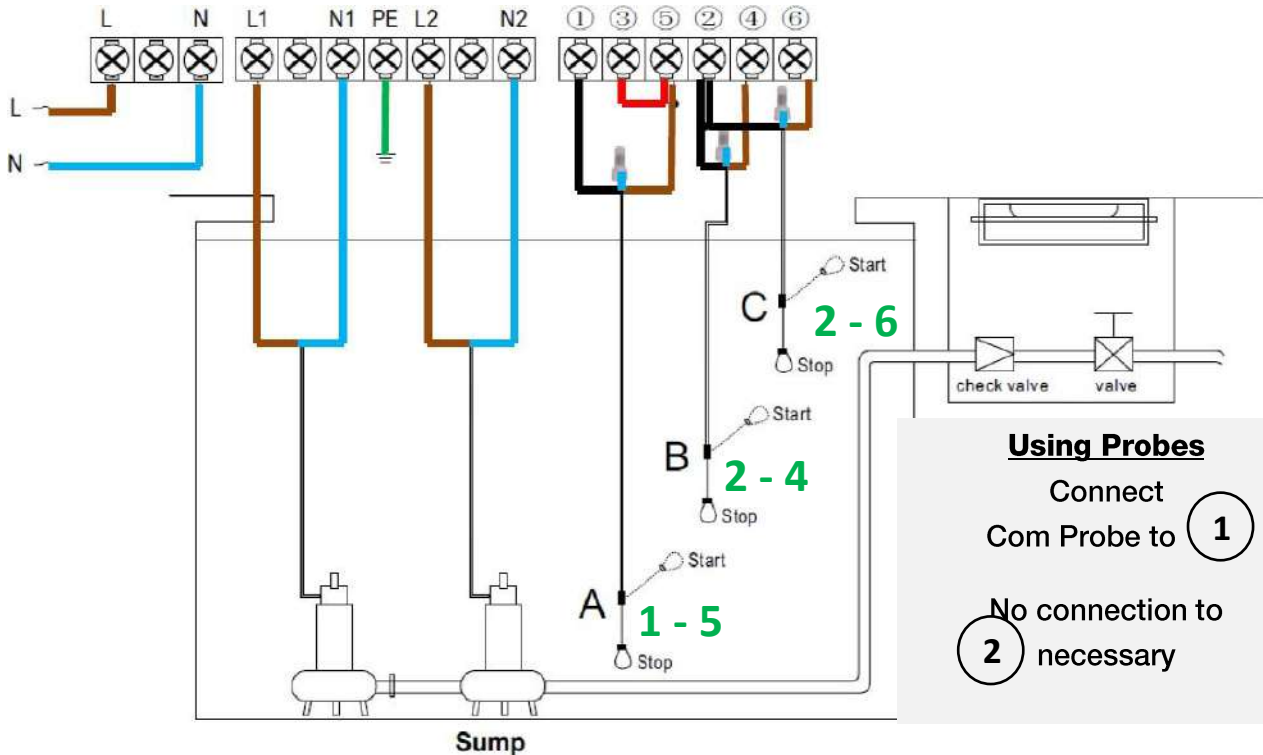

**Pump Calibration:** Note each pump requires its own calibration

Press and **MODE** **STORE** Hold for 10 seconds to move from Auto to Manual mode.

The display will indicate **MANUAL** MODE

Press **A START** or **B START** and allow the pump to run until it is running at its duty point and the amps stabilize.

Press **STORE** The control panel will beep. Press **MODE** to return to **AUTO**

# 13. Quick guide: Drainage Pumps with floats connected.

**Set the dip switches on the inside of the door and cycle the MCB**

Note: No dry run protection when using this mode.

Bridge 1 - 3 - 5 also 2 - 4

Control panel alternates active pump every 240 hrs (user adjustable)



DRAINAGE SETTING FOR AUTOMATIC PUMPS

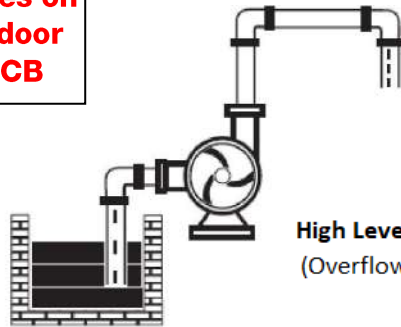

DRAINAGE SYMBOL

High Level (Overflow) 2 - 6

Both pumps activated together for 30 min after alarm condition

15 min delay before lights or buzzer activate to allow 2nd pump to assist pump out

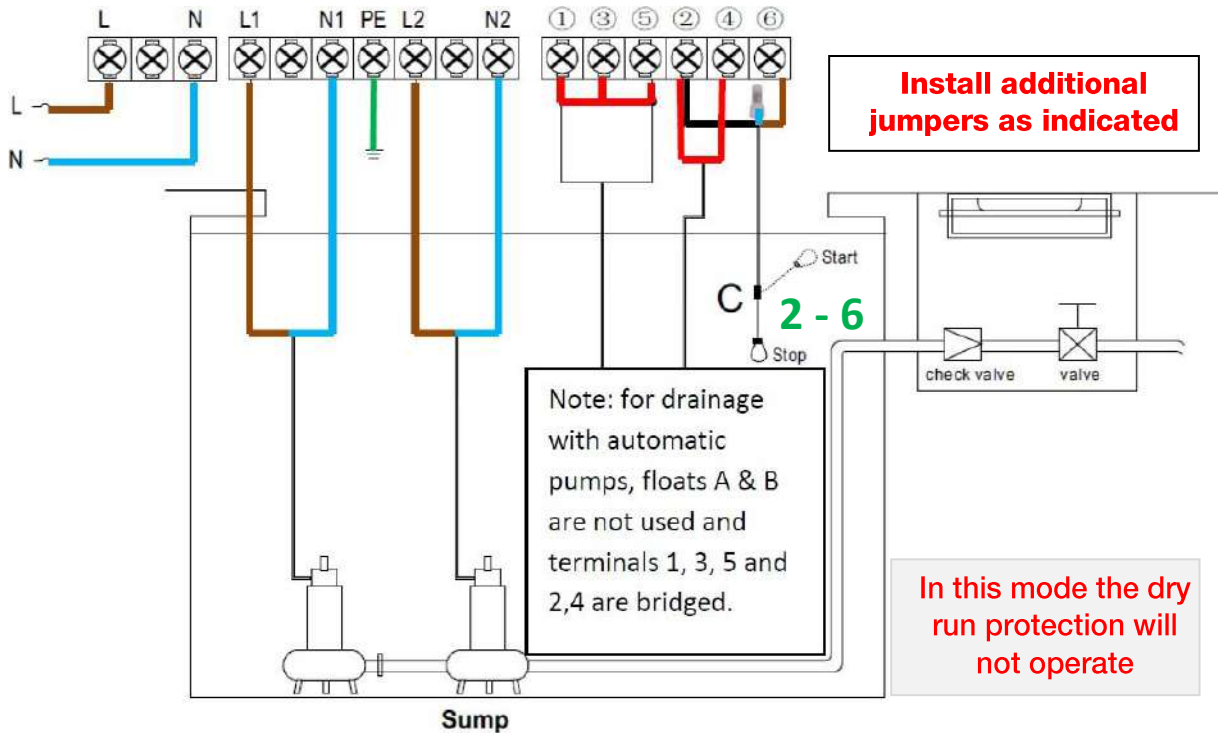

**Install additional jumpers as indicated**

Note: for drainage with automatic pumps, floats A & B are not used and terminals 1, 3, 5 and 2, 4 are bridged.

In this mode the dry run protection will not operate

## Pump Calibration: Note each pump requires its own calibration

Press and Hold **MODE** **STORE** for 10 seconds to move from Auto to Manual mode. The display will indicate **MANUAL** MODE

Press **A START** or **B START** and allow the pump to run until it is running at its duty point and the amps stabilize.

Press **STORE** The control panel will beep. Press **MODE** to return to **AUTO**

# 14. Quick guide: Pressure boosting

**Set the dip switches on the inside of the door and cycle the MCB**

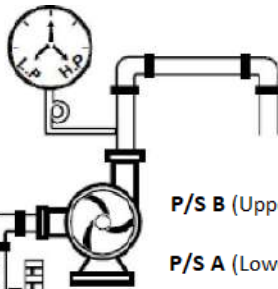

**Bridge 1 - 3 - 5**

Control panel alternates active pump every 240 hrs (User Adjustable)

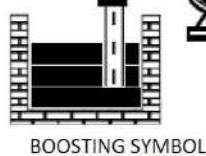

**P/S B (Upper setpoint) 2 - 6** First pump starts

**P/S A (Lower setpoint) 2 - 4** If pressure drops to the point where **P/S A** activates, the 2nd pump runs  
Once pressure exceeds **P/S A (2 - 4)** both pumps run until **P/S B (2 - 6)** switches off

**Terminals 9&11 and 10&12 are to connect microtherms**  
**Leave jumpers in place**

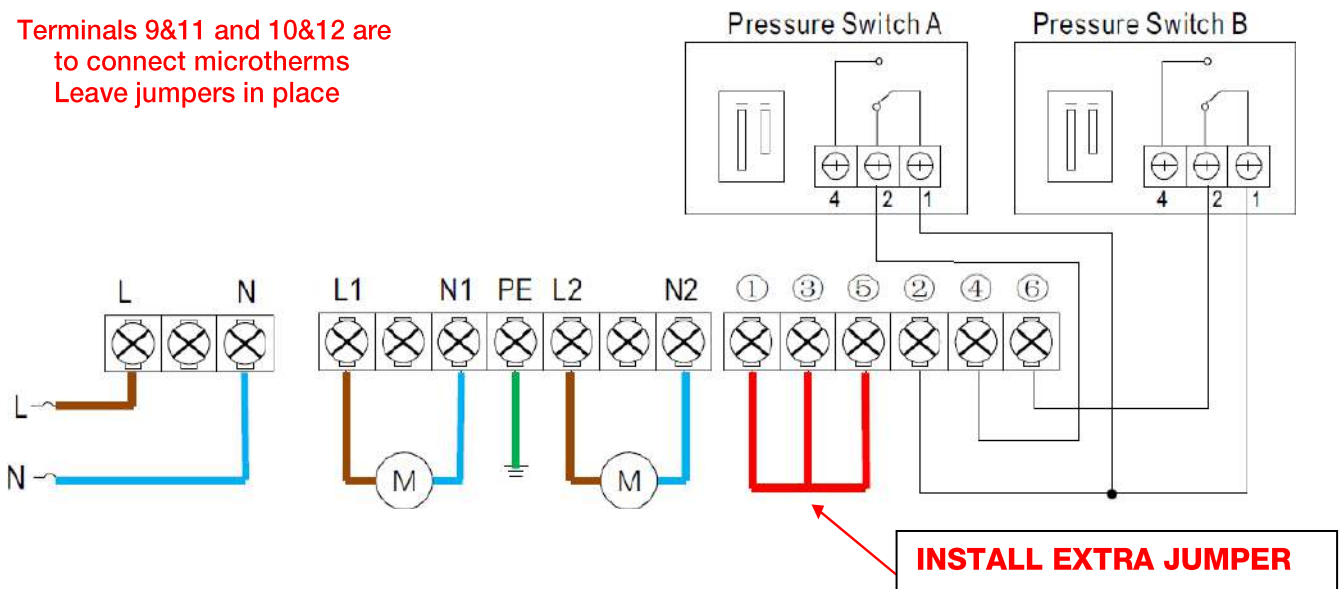

**Additional RUN/NO Control can be achieved by removing the 1-3-5 jumper and connecting between the 1 - 5 terminals**

When terminals **1 - 5** are open circuit the pump(s) will NOT RUN. With **1 - 5** in a closed condition, the pump(s) will run according to the **2 - 4** and **2 - 6** control circuits.

**Pump Calibration:** Note each pump requires its own calibration

Press and Hold **MODE** **STORE** for 10 seconds to move from Auto to Manual mode.  
The display will indicate **MANUAL** MODE

Press **A START** or **B START** and allow the pump to run until the pump is running at its duty point and the amps stabilize.

Press **STORE** The control panel will beep. Press **MODE** to return to **AUTO**

# 15. Quick guide: Transfer; source and destination control

**Set the dip switches on the inside of the door and cycle the MCB**



TRANSFER SETTING

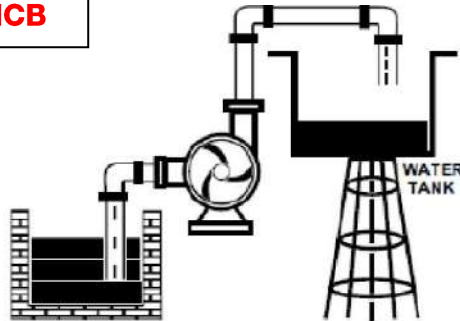

TRANSFER SYMBOL

**Source level 1 - 3** Must be in the up (on) position for operation  
 Down (off) position prevents and/or stops all pumping.

**Bridge 4 - 6**

Terminals 9&11 and 10&12 are to connect microtherms  
 Leave jumpers in place

**Normal demand 2 - 6 (A)** When Float A (2 - 6) is in the down (closed) position a single pump operates.

**High demand 2 - 5 (B)** If level continues to drop with single pump running and Float B (2 - 5) reaches the down position, both pumps will run until both Float A and B are in the up (full) position

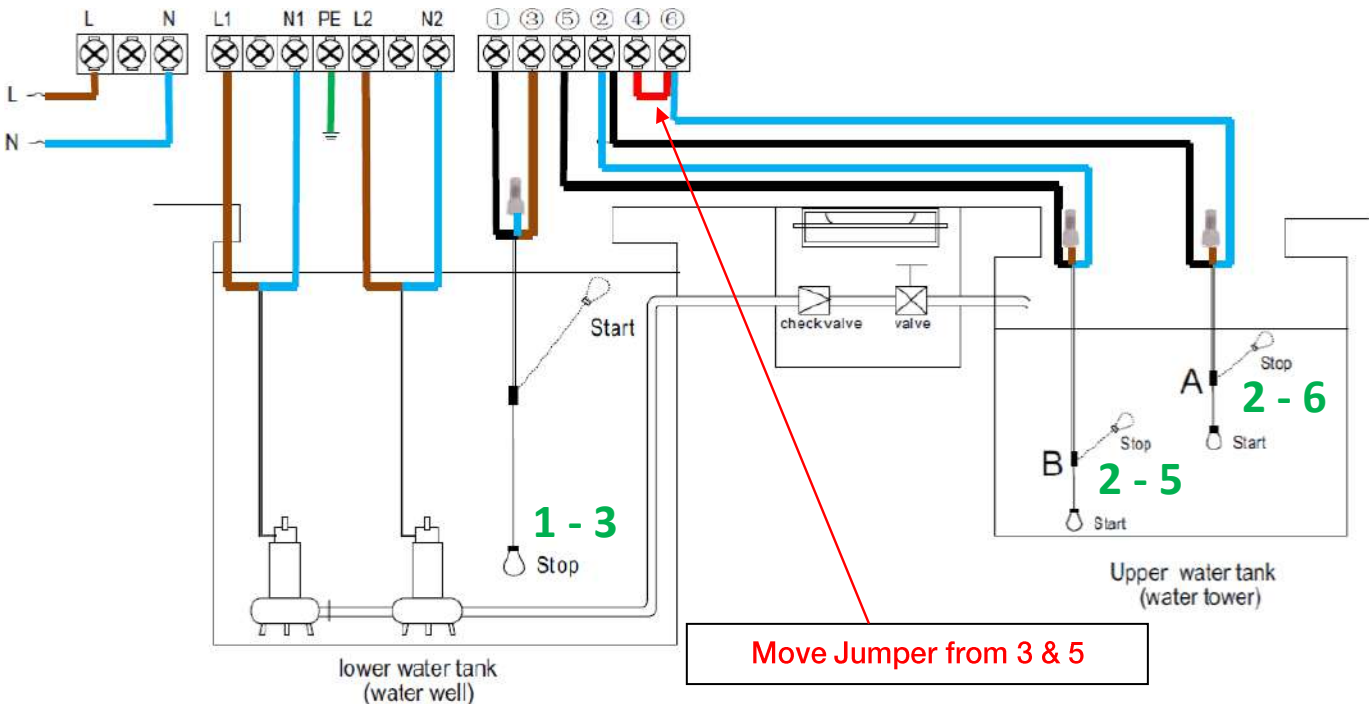

Float 1-3 Monitors water level in the supply tank and prevents the pumps from running if insufficient water available. Float can be removed and terminals 1- bridged

**Pump Calibration:** Note each pump requires its own calibration

← Refer to page 19

# 16. Quick guide: Transfer mode - thermostatic control

Set the dip switches on the inside of the door and cycle the MCB



TRANSFER SETTING FOR HOT WATER CIRCULATION

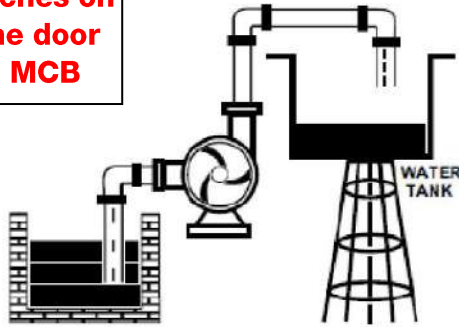

TRANSFER SYMBOL

Bridge - see notes

Control panel alternates active pump every 240 hrs (user adjustable)

2 - 4 A thermostat can be installed between 2 - 4 to switch the circulators on or off

Terminals 9&11 and 10&12 are to connect microtherms  
Leave jumpers in place

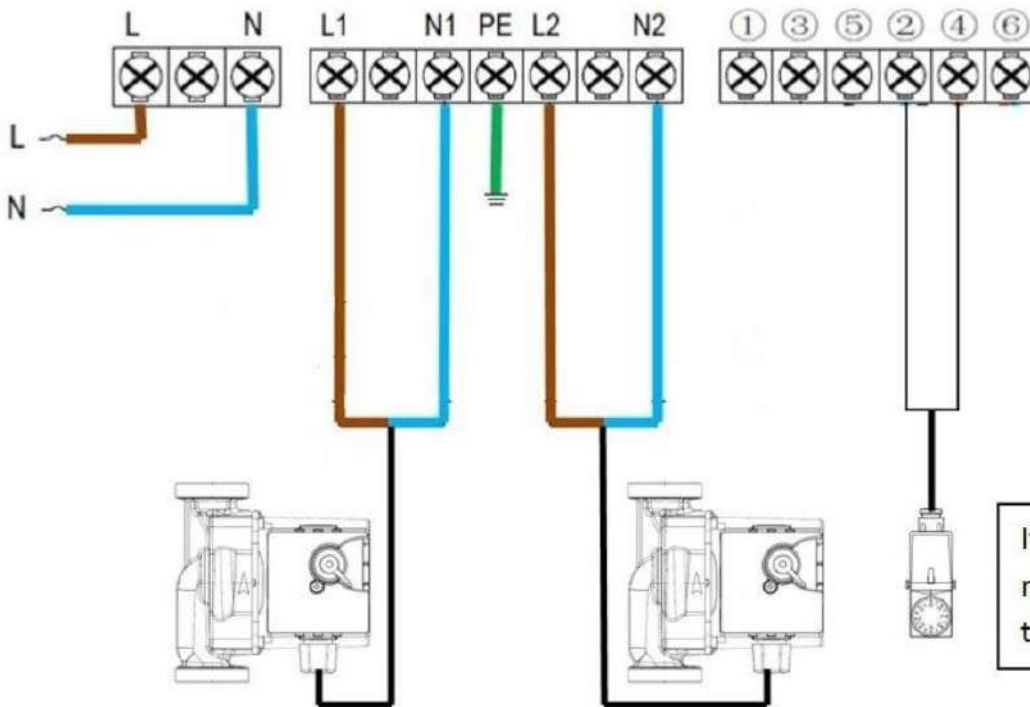

**Pump Calibration:** Note each pump requires its own calibration

Press and Hold **MODE** **STORE** for 10 seconds to move from Auto to Manual mode.  
The display will indicate **MANUAL** MODE

Press **A START** or **B START** and allow the pump to run until the pump is running at its duty point and the amps stabilize.

Press **STORE** The control panel will beep. Press **MODE** to return to **AUTO**

## 17. Fault messages – possible causes and solutions

Fault Message	Possible Cause	Solutions
Flashing <b>PUMP NO CALIBRATION</b> Parameter 007 / 008 or perform the auto calibration sequence	Pump calibration has not been completed.	See Pg 11 for calibration instructions.
Flashing <b>DRY RUN</b> Parameter 004 and 009	Water level in the well/sump is below pump intake, pump stops running.  Broken outlet pipe	DPC will attempt to restart the pump every 30 minutes until water level restored.
Flashing <b>OVER LOAD</b> Parameter 005 and 010	Pump running amps greater than calibrated running amps, pump is in overload protection state.  Pump damage, dragging impeller or bearing, possible clogging.  Pump calibrated without water or with a nominal amperage value	DPC will attempt to restart the pump every 30 minutes until running amps restored to normal.  Inspect and/or repair pump.  Erase previous calibration and recalibrate with water.
Flashing <b>PUMP STALLED</b> Parameter 011	Pump running amps greater than 200% of calibrated running amps  Pump Stalled protection indicates a 'Critical Error' suggesting obstruction to the impeller or cutting mechanism	Cut off power supply, inspect, repair or replace pump.  Controller will require power cycled to reset
Flashing <b>UNDER V</b> Parameter 006 and 012	Voltage is lower than the calibrated voltage. The pump is in under voltage protection state.	DPC will attempt to restart the pump every 5 minutes until normal voltage is restored.
Flashing <b>OVER V</b> Parameter 006 and 013	Voltage is higher than the calibrated voltage. The pump is in the over-voltage protection state.	DPC will attempt to restart the pump every 5 minutes until normal voltage is restored.
Flashing <b>REPEATED START</b>	Pump starts more than 5 times per minute.  Liable to occur in pressure boosting mode only. Unlikely that this could occur in drainage or transfer mode unless there is a wiring fault.	Check pressure switch settings are correct for application.  Check pressure tank pre-charge pressure and condition of diaphragm (if fitted)  Check the volume of sump is not too small.
Flashing <b>OVER TEMP</b>	The jumper on temperature protection terminals has been removed.  Pump motor temperature high and pump thermal switch in open state (if connected).	Reinstall jumper on temperature protection terminals.  Wait until pump motor temperature reduces. Investigate cause for Overheating.
 ON LINE	No communication between Slave controller and DPC Distance to SC excessive	Connect remote monitor to enable remote monitoring/control



## 18. Warranties – Terms and Conditions

This warranty is given in addition to the consumer guarantees found within the Australian Competition and Consumer Act 2010 (Cth) for goods purchased in Australia and the Consumer Guarantees Act 1993 NZ for goods purchased in New Zealand:



1) White International Pty Ltd / White International NZ Ltd (White International) warrant that all products distributed are free from defects in workmanship and materials, for their provided warranty period as indicated on the top or opposite side of this document. Subject to the conditions of the warranty, White International will repair any defective products free of charge at the premises of our authorised service agents throughout Australia and New Zealand if a defect in the product appears during the warranty period. If you believe that you have purchased a defective product and wish to make a claim under this warranty, contact us on our Sales Hotline on 1300 783 601, or send your claim to our postal address or fax line below and we will advise you as to how next to proceed. You will be required to supply a copy of your proof of purchase to make a claim under this warranty.

2) This warranty excludes transportation costs to and from White International or its appointed service agents and excludes defects due to non-compliance with installation instructions, neglect or misuse, inadequate protection against the elements, low voltage or use or operation for purposes other than those for which they were designed. For further information regarding the suitability of your intended application contact us on our Sales Hotline on 1300 783 601. If you make an invalid claim under this warranty, the original product will be sent back to you unrepai red.

3) This warranty refers only to products sold after the 1st January 2012, and is not transferable to another product type and only applies to the original owner, purchaser or end user, and is in addition to the consumer guarantees found within the Competition and Consumer Act 2010 (Cth) for goods purchased in Australia and the Consumer Guarantees Act 1993 (NZ) for goods purchased in New Zealand.

4) Our goods come with guarantees that cannot be excluded under the Australian Consumer Law. You are entitled to a replacement or refund for a major failure and for compensation for any other reasonably foreseeable loss or damage. You are also entitled to have the goods repaired or replaced if the goods fail to be of acceptable quality and the failure does not amount to a major failure. 2 YEAR WARRANTY

5) To the fullest extent permitted by law, White International excludes its liability for all other conditions or warranties which would or might otherwise be implied at law. To the fullest extent permitted by law, White International's liability under this warranty and any other conditions, guarantees or warranties at law that cannot be excluded, including those in the Competition and Consumer Act 2010 (Cth), is expressly limited to: (a) in the case of products, the replacement of the product or the supply of equivalent product, the payment of the cost of replacing the product or of acquiring an equivalent product or the repair of the product or payment of the cost of having the product repaired, is at the discretion of White International or a 3rd party tribunal elected under the Competition and Consumer Act 2010 (Cth) for goods purchased in Australia and the Consumer Guarantees Act 1993 (NZ) for goods purchased in New Zealand; and

6) To the fullest extent permitted by law, this warranty supersedes all other warranties attached to the product or its packaging.

7) In the case of services, supplying the services again or the payment of the cost of having the services supplied again, is at the discretion of White International or a 3rd party tribunal elected under the Competition and Consumer Act 2010 (Cth) for goods purchased in Australia and the Consumer Guarantees Act 1993 (NZ) for goods purchased in New Zealand. 8) Our warranty commences from the date of purchase of the above-mentioned pumps. Proof of purchase is required before consideration under warranty is given.

*Record your date of purchase in the space below and retain this copy for your records.*

**Date of Purchase** .....**Model Purchased** .....



**[www.whiteint.com.au](http://www.whiteint.com.au)**

**1300 783 601**

**[www.whiteint.co.nz](http://www.whiteint.co.nz)**

**0800 509 506**

**Please always refer to our website for further technical information & new product innovations**

**Disclaimer:** Every effort has been made to publish the correct information in this manual. No responsibility will be taken for errors, omissions or changes in product specifications.

© 2020 Copyright White International Pty Ltd

TM ® - WARNING: Please be aware that various brands & products depicted within this document are subject to trademark, patent or design registrations. Infringement of any intellectual property contained within this document without express written authority by the appropriate intellectual property holder may result in further legal action to be taken. For any queries regarding use of the contained information please feel free to contact White International Pty Ltd.